

MUGEN COATING PREMIUM Plus
2-Flute Long Neck Ball End Mill
with Short Shank for Hardened Steel and High accuracy cutting

MRBSH230SF

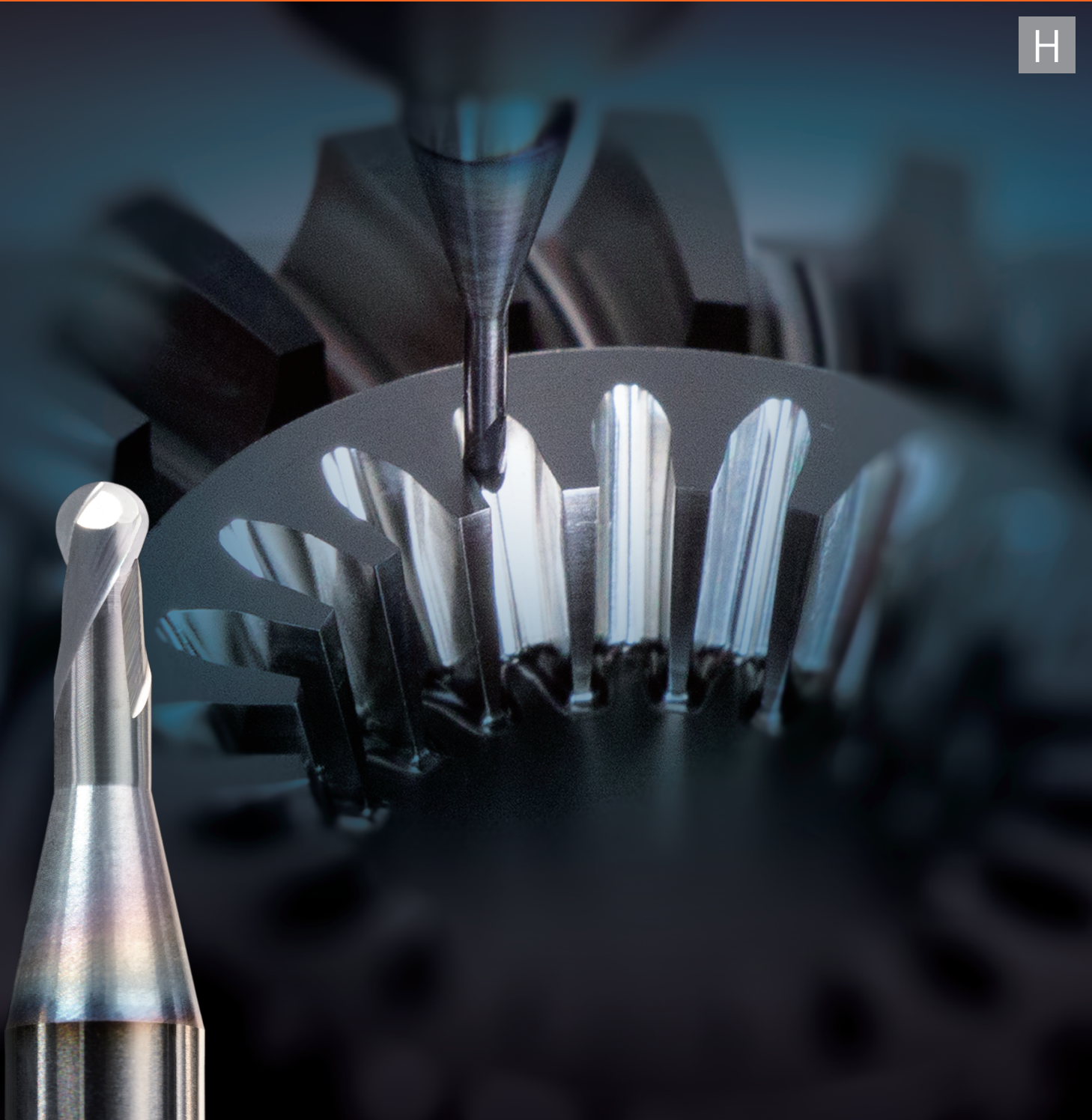

High precision and long tool life even for hardened steel up to 70 HRC

MRBSH230SF

R0.05 ~ R3 Total 83 sizes



MUGEN COATING PREMIUM Plus

New developed coating realized cutting hardened steel up to 70HRC with high oxidation resistance and abrasion resistance

Features of hardened steel

As a phenomenon when machining hardened steel of 60 to **70 HRC**, the cutting load during processing is extremely high because hardness and toughness of work material are high. Therefore, the "shearing action" at tool edge cause that...

- Tools to wear easily causing frict
- Tools tends to wear to reduced hardness of material on coating oxidizes of cutting heat
- Tool is easily damaged if impact force is large

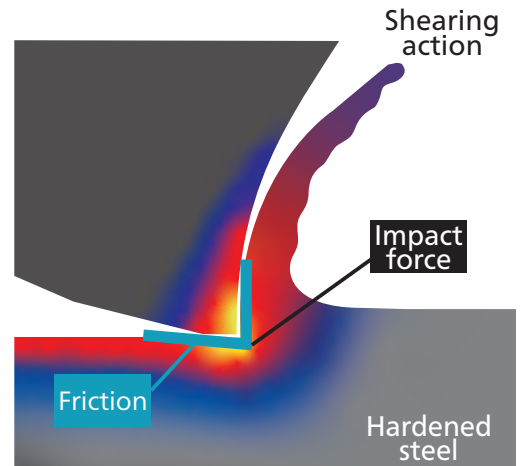

Coating structure

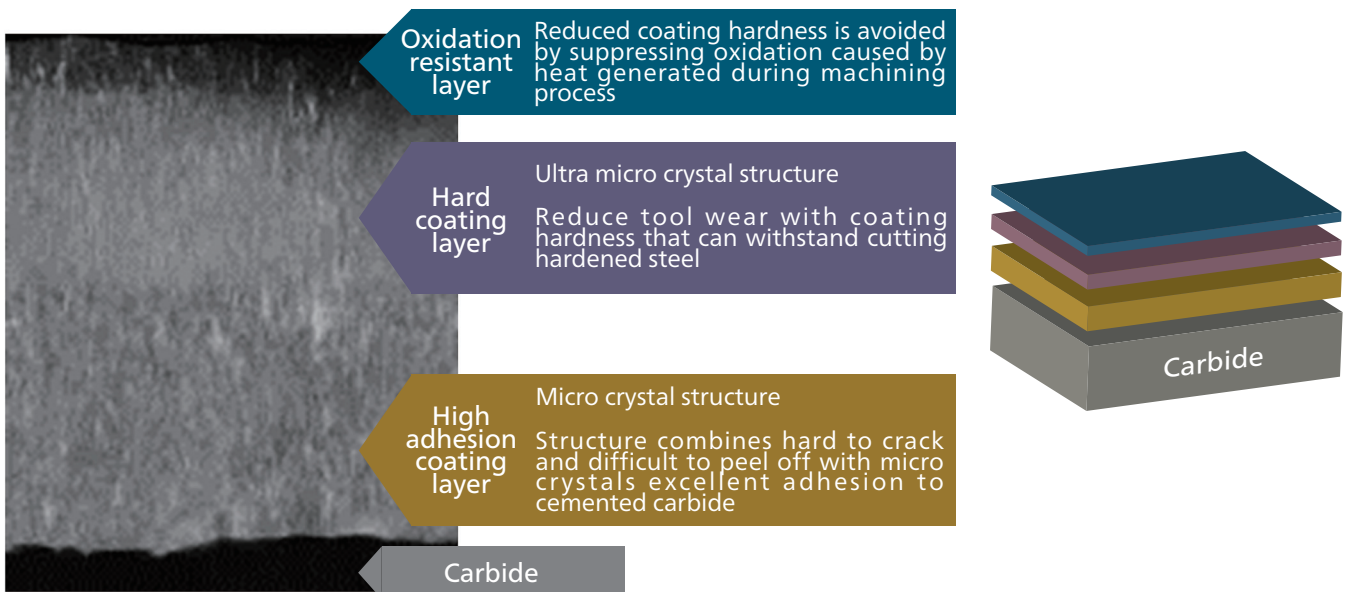

Work material hardness

	MUGEN COATING	MUGEN COATING PREMIUM	MUGEN COATING PREMIUM Plus
Work Material Hardness	50 HRC	60 HRC	70 HRC

Optimized for cutting 60 to 70 HRC material

Role of coating

Oxidation resistant layer

Prevents oxidation due to heat generated during cutting

Hard coating layer (Ultra micro crystal structure)

Image of wear progress cross section of coating

Tool wear can be reduced when machining on high hardened steel

High adhesion coating layer (micro crystal structure)

Image diagram of crack growth and adhesion

Cross section of coating

Structure that is difficult to crack and propagate when impact forced

High adhesion

Tool life comparison for HAP40 (64HRC)

Cutting condition:

$n = 20,000 \text{ min}^{-1}$, $V_f = 1,600 \text{ mm/min}$, $a_p = 0.15 \times a_e = 0.3 \text{ mm}$, Coolant: Oil mist

	MRBSH230SF	Other tool brand A	Other tool brand B	Other tool brand C
Wear pictures	 Wear width : 0.102mm	 Wear width : 0.137mm	 Wear width : 0.190mm	 Wear width : 0.157mm
Cutting time	70 min			

High precision and long tool life even for hardened steel up to 70 HRC

MRBSH230SF

R0.05 ~ R3 Total 83 sizes

Achieves long tool life and high precision cutting even for 70HRC hardened steel



R accuracy is based on a half value of actual diameter

Features



Coating

1	New coating MUGEN COATING PREMIUM Plus with high Oxidation resistance and abrasion resistance
----------	-----------------------------------------------------------------------------------------------

Introduced in the previous page

Shape

2-1	Cutting edge shape with reduced cutting load
2-2	Achieves high rigidity with optimal tool overhung High accuracy precision shank supported shrink fit chuck
2-3	Highly accurate R shape that is smooth and seamless

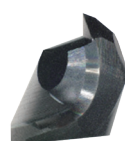

Tolerance range
0.002 mm

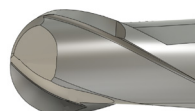

Material

3	Super micro grain carbide with improved fracture resistance
----------	-------------------------------------------------------------

Feature
2-1

Improved machinability

Shape

Cutting edge

Sharp cutting edge with reduced cutting load and new material with fracture resistance realizes long tool life and high precision for hardened steel

MRBSH230SF

General end mill
for hardened steel

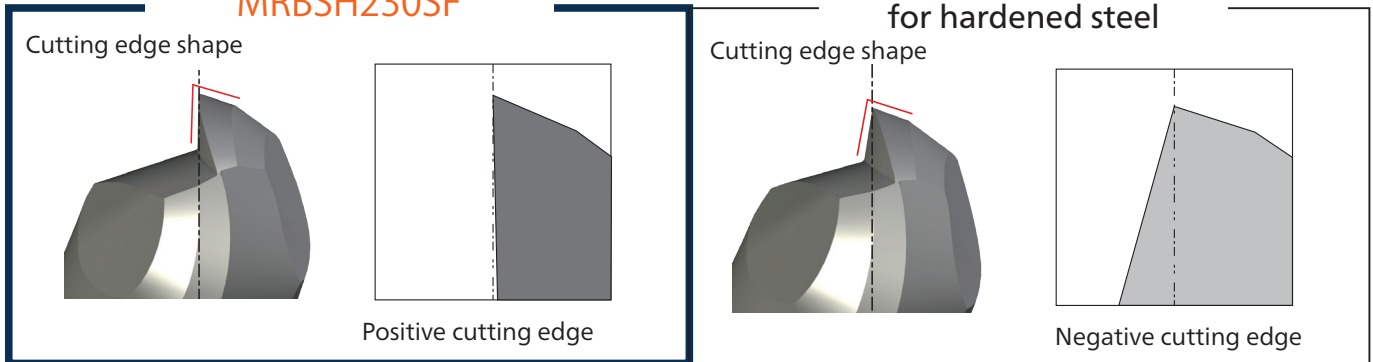

Cutting load is reduced by positive cutting edge and by adopting a new material Super micro grain carbide prevent chipping even with hardened steel

Negative cutting edge shape with high cutting load

Feature
2-2

Improved cutting accuracy

Shape

Optimal overhung length

MRBSH230SF

Normal shank length

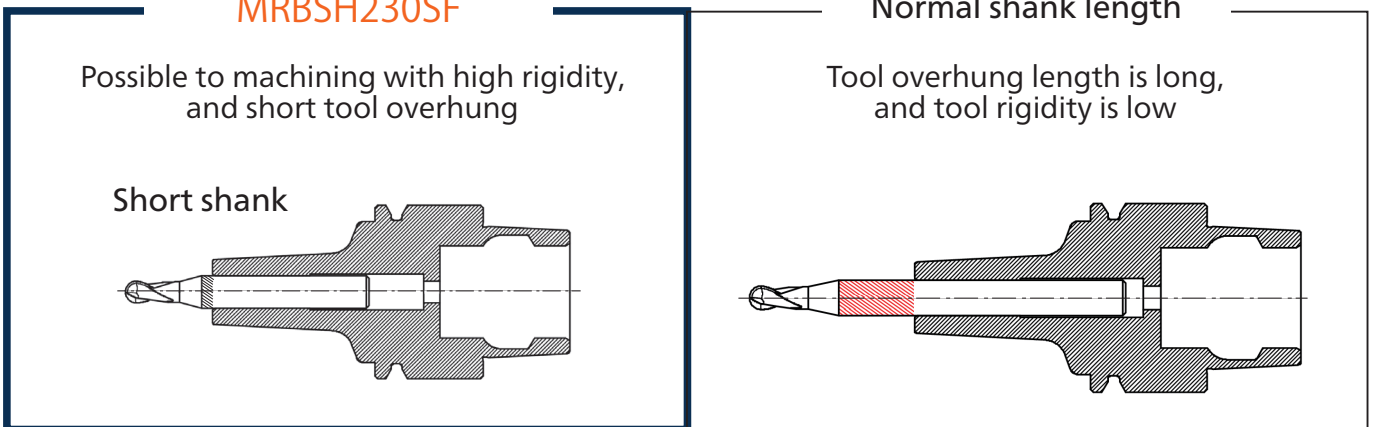

Feature
2-2

Compatible with high accuracy
shrink-fit chuck

Shape

High accuracy shank



High precision and long tool life even for hardened steel up to 70 HRC

Feature
2-3

High accuracy R

Shape Highly accurate R

Seamless design on rake face and flank face from R-curve to peripheral cutting edge realized high precision R accuracy

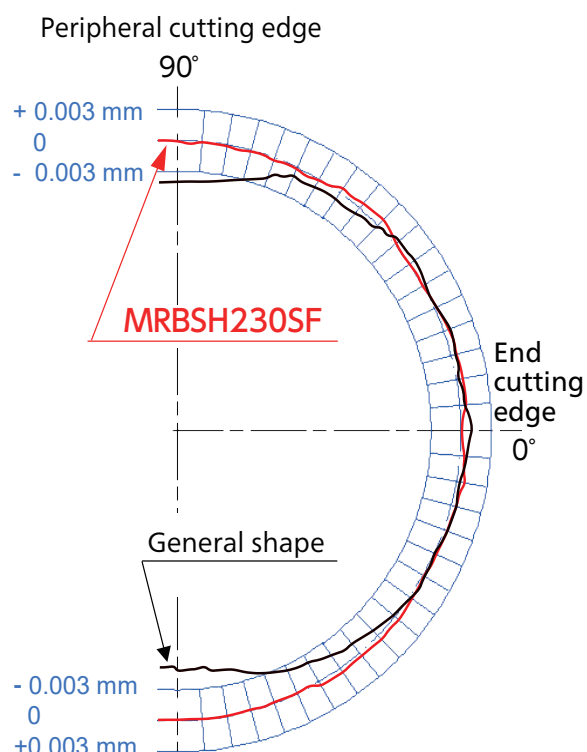
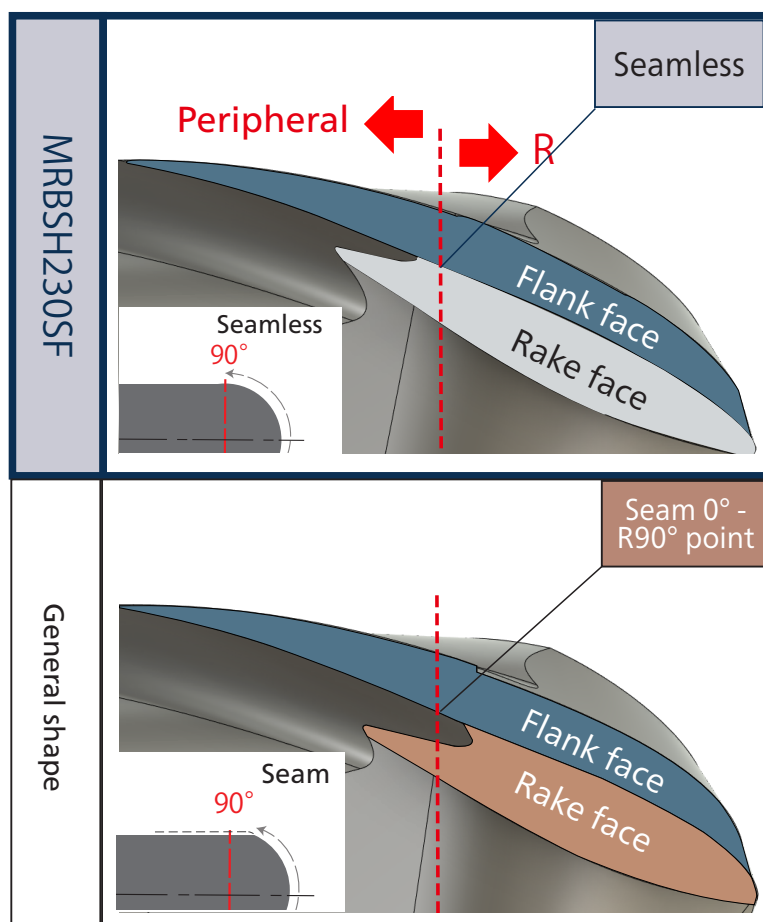

* R accuracy is based on a half value of actual diameter.

Feature
3

Upgrade abrasion ability

Material Carbide material



New material adopted 「**Super micro grain carbide**」 to specialize abrasion resistance and fracture resistance.

High precision cutting sample 1

HAP72 (70HRC)
 Comparison of dimensional accuracy after roughing
 Tool : MRBSH230SF R1x6
 Cutting content:
 Roughing contour lines for 4 pockets
 Stock : 0.02mm
 Target : 7.960mm
 Cutting time : 20min/per pocket
 Tool path : Roughing contour line

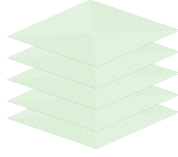

Cutting shape
 Pocket size: 8mm x 8mm x cutting depth 6mm

HAP72 (70HRC)

Roughing

$n = 16,000 \text{ min}^{-1}$, $V_f = 1,200 \text{ mm/min}$, $a_p 0.1 \times a_e 0.3 \text{ mm}$, Oil Mist

Tool wear condition after 80min machining

MRBSH230SF

Frank wear width
0.055mm

Other tool brand

Frank wear width
0.102mm

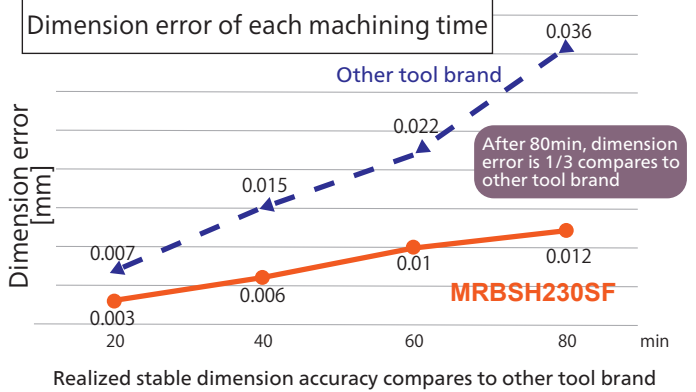

High precision cutting sample 2

HAP72 (70HRC)
 Comparison of dimensional accuracy after finishing
 Tool : MRBSH230SF R1x6
 Cutting content: Finishing for 1 pocket

Cutting time : 32min/per pocket
 Tool path : Contour line finishing (Side)
 Scanning line finishing (Bottom)

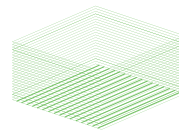

Finishing

$n = 16,000 \text{ min}^{-1}$, $V_f = 1,000 \text{ mm/min}$, $a_p 0.03 \times a_e 0.03 \text{ mm}$, Oil Mist

Cutting shape
 Pocket Size: 30mm x 30mm x cutting depth 6mm

HAP72 (70HRC)

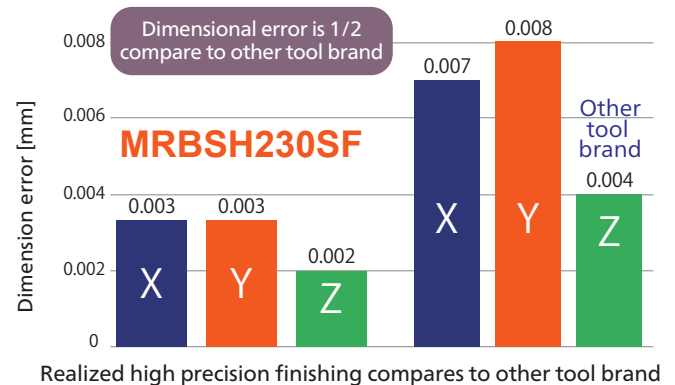

MUGEN COATING PREMIUM Plus
2-Flute Long Neck Ball End Mill with Short Shank for Hardened Steel

Total 83 Size

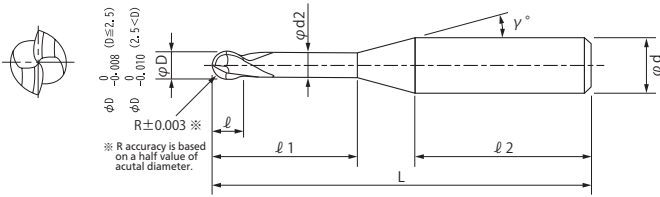

R accuracy is based on a half value of actual diameter

- Realize stable cutting performance even for 70 HRC hardened steels.
- Developed new MUGEN COATING PREMIUM Plus to upgrade oxidation resistance and abrasion resistance.
- Adopt optimized new tool material and tool design to reduce cutting load.
- R accuracy is ± 0.003 mm (R accuracy is based on a half value of actual diameter).
- Shank diameter tolerance, high accuracy type, is -0.001 ~ -0.003.

Work Material

Hardened Steels	
45 ~ 60 HRC	60 ~ 70 HRC
○	◎

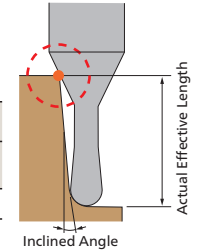

Unit [Size : mm]

Code No.	Radius (R)	Under Neck Length (l1)	Length of Cut (l)	Dia. (D)	Neck Dia. (d2)	Neck Taper Angle (γ)	Shank Dia. (d)	Shank Length (l2)	Overall Length (L)	Actual effective length depending on inclined angle of workpiece.				
										30°	1°	1°30'	2°	3°
08-00537-00052	R0.05	0.2	0.07	0.1	0.085	15°	4	27.4	35	0.23	0.24	0.24	0.25	0.27
08-00537-00053		0.3	0.07	0.1	0.085	15°	4	27.3	35	0.33	0.34	0.35	0.36	0.39
08-00537-00055		0.5	0.07	0.1	0.085	15°	4	27.1	35	0.54	0.56	0.57	0.59	0.64
08-00537-00072	R0.075	0.3	0.1	0.15	0.13	15°	4	27.4	35	0.34	0.35	0.36	0.37	0.40
08-00537-00073		0.5	0.1	0.15	0.13	15°	4	27.2	35	0.55	0.56	0.58	0.60	0.65
08-00537-00101	R0.1	0.3	0.15	0.2	0.18	15°	4	27.5	35	0.34	0.35	0.36	0.37	0.39
08-00537-00102		0.5	0.15	0.2	0.18	15°	4	27.3	35	0.55	0.56	0.58	0.60	0.64
08-00537-00103		0.75	0.15	0.2	0.18	15°	4	27.1	35	0.81	0.83	0.86	0.89	0.95
08-00537-00105	R0.15	1	0.15	0.2	0.18	15°	4	26.8	35	1.06	1.10	1.13	1.17	1.26
08-00537-00150		0.5	0.2	0.3	0.28	15°	4	27.5	35	0.55	0.56	0.57	0.59	0.63
08-00537-00151		0.6	0.2	0.3	0.28	15°	4	27.4	35	0.65	0.67	0.69	0.71	0.75
08-00537-00152	R0.2	0.75	0.2	0.3	0.28	15°	4	27.3	35	0.80	0.83	0.85	0.88	0.94
08-00537-00153		1	0.2	0.3	0.28	15°	4	27.0	35	1.06	1.09	1.13	1.17	1.25
08-00537-00155		1.5	0.2	0.3	0.28	15°	4	26.5	35	1.58	1.63	1.68	1.74	1.87
08-00537-00201	R0.25	0.5	0.3	0.4	0.37	15°	4	27.7	35	0.56	0.58	0.59	0.60	0.64
08-00537-00202		0.8	0.3	0.4	0.37	15°	4	27.4	35	0.87	0.90	0.92	0.95	1.01
08-00537-00203		1	0.3	0.4	0.37	15°	4	27.2	35	1.08	1.11	1.14	1.18	1.26
08-00537-00204		1.5	0.3	0.4	0.37	15°	4	26.7	35	1.60	1.65	1.70	1.75	1.88
08-00537-00205		2	0.3	0.4	0.37	15°	4	26.2	35	2.11	2.18	2.25	2.33	2.50
08-00537-00206	R0.3	2.5	0.3	0.4	0.37	15°	4	25.7	35	2.63	2.72	2.81	2.90	3.13
08-00537-00252		1	0.35	0.5	0.46	15°	4	27.3	35	1.10	1.13	1.16	1.19	1.27
08-00537-00253		1.5	0.35	0.5	0.46	15°	4	26.8	35	1.61	1.66	1.71	1.77	1.89
08-00537-00254		2	0.35	0.5	0.46	15°	4	26.3	35	2.13	2.20	2.27	2.34	2.51
08-00537-00255		2.5	0.35	0.5	0.46	15°	4	25.8	35	2.65	2.73	2.82	2.92	3.14
08-00537-00256	R0.4	3	0.35	0.5	0.46	15°	4	25.3	35	3.16	3.27	3.38	3.49	3.76
08-00537-00300		1	0.45	0.6	0.56	15°	4	27.5	35	1.10	1.12	1.15	1.19	1.26
08-00537-00301		1.5	0.45	0.6	0.56	15°	4	27.0	35	1.61	1.66	1.71	1.76	1.88
08-00537-00302		2	0.45	0.6	0.56	15°	4	26.5	35	2.13	2.19	2.26	2.34	2.50
08-00537-00303		2.5	0.45	0.6	0.56	15°	4	26.0	35	2.65	2.73	2.82	2.91	3.12
08-00537-00304	R0.5	3	0.45	0.6	0.56	15°	4	25.5	35	3.16	3.26	3.37	3.49	3.75
08-00537-00305		3.5	0.45	0.6	0.56	15°	4	25.0	35	3.68	3.80	3.92	4.06	4.37
08-00537-00306		4	0.45	0.6	0.56	15°	4	29.5	40	4.20	4.33	4.48	4.64	4.99
08-00537-00402		2	0.6	0.8	0.76	15°	4	26.9	35	2.13	2.19	2.25	2.32	2.48
08-00537-00403		3	0.6	0.8	0.76	15°	4	25.9	35	3.16	3.26	3.36	3.47	3.72
08-00537-00405	R0.5	4	0.6	0.8	0.76	15°	4	24.9	35	4.19	4.33	4.47	4.62	4.97
08-00537-00406		5	0.6	0.8	0.76	15°	4	28.9	40	5.23	5.40	5.58	5.77	6.21
08-00537-00501		2	0.75	1	0.95	15°	4	27.3	35	2.14	2.20	2.26	2.33	2.48
08-00537-00502		2.5	0.75	1	0.95	15°	4	26.8	35	2.66	2.73	2.82	2.90	3.10
08-00537-00503		3	0.75	1	0.95	15°	4	26.3	35	3.18	3.27	3.37	3.48	3.72
08-00537-00504	R0.5	4	0.75	1	0.95	15°	4	25.3	35	4.21	4.34	4.48	4.63	4.97
08-00537-00505		5	0.75	1	0.95	15°	4	29.3	40	5.24	5.41	5.59	5.78	6.21
08-00537-00506		6	0.75	1	0.95	15°	4	28.3	40	6.28	6.48	6.69	6.93	7.45

How to order

When you order, indicate MRBSH230SF (R) x (l1).

※ (γ) is reference value.

Unit [Size : mm]

Code No.	Radius (R)	Under Neck Length (ℓ1)	Length of Cut (ℓ)	Dia. (D)	Neck Dia. (d2)	Neck Taper Angle (γ)	Shank Dia. (d)	Shank Length (ℓ2)	Overall Length (L)	Actual effective length depending on inclined angle of workpiece.					
										30'	1°	1°30'	2°	3°	
08-00537-00602	R0.6	2.4	0.9	1.2	1.15	15°	4	27.2	35	2.55	2.62	2.69	2.77	2.95	
08-00537-00603		4	0.9	1.2	1.15	15°	4	25.6	35	4.21	4.33	4.47	4.61	4.94	
08-00537-00605		6	0.9	1.2	1.15	15°	4	28.6	40	6.27	6.47	6.68	6.91	7.43	
08-00537-00606		8	0.9	1.2	1.15	15°	4	26.6	40	8.34	8.61	8.90	9.21	9.91	
08-00537-00752	R0.75	3	1.1	1.5	1.45	15°	4	27.2	35	3.17	3.25	3.34	3.44	3.66	
08-00537-00753		4	1.1	1.5	1.45	15°	4	26.2	35	4.20	4.32	4.45	4.59	4.91	
08-00537-00754		6	1.1	1.5	1.45	15°	4	29.2	40	6.27	6.46	6.67	6.89	7.39	
08-00537-00755		8	1.1	1.5	1.45	15°	4	27.2	40	8.34	8.60	8.88	9.19	9.88	
08-00537-00756	R0.8	10	1.1	1.5	1.45	15°	4	25.2	40	10.40	10.74	11.10	11.49	12.36	
08-00537-00805		8	1.2	1.6	1.55	15°	4	27.4	40	8.33	8.60	8.88	9.18	9.87	
08-00537-01000		R1	3	1.5	2	1.94	15°	4	28.1	35	3.18	3.25	3.34	3.43	3.63
08-00537-01001			4	1.5	2	1.94	15°	4	27.1	35	4.21	4.32	4.45	4.58	4.87
08-00537-01002	6		1.5	2	1.94	15°	4	25.1	35	6.28	6.46	6.66	6.88	7.36	
08-00537-01003	8		1.5	2	1.94	15°	4	28.1	40	8.35	8.60	8.88	9.18	9.84	
08-00537-01004	10		1.5	2	1.94	15°	4	26.1	40	10.41	10.74	11.10	11.48	12.33	
08-00537-01005	12		1.5	2	1.94	15°	4	29.1	45	12.48	12.88	13.31	13.77	14.82	
08-00537-01252	R1.25	6	2.3	2.5	2.4	15°	4	26.0	35	6.35	6.53	6.72	6.92	7.39	
08-00537-01253		8	2.3	2.5	2.4	15°	4	29.0	40	8.42	8.67	8.93	9.22	9.88	
08-00537-01254		10	2.3	2.5	2.4	15°	4	27.0	40	10.48	10.81	11.15	11.52	12.36	
08-00537-01256		15	2.3	2.5	2.4	15°	4	27.0	45	15.65	16.15	16.69	17.27	Free	
08-00537-01500	R1.5	6	2.5	3	2.85	15°	6	33.1	45	6.44	6.61	6.79	7.00	7.45	
08-00537-01501		8	2.5	3	2.85	15°	6	31.1	45	8.5	8.75	9.01	9.29	9.93	
08-00537-01502		10	2.5	3	2.85	15°	6	29.1	45	10.57	10.89	11.23	11.59	12.42	
08-00537-01503		12	2.5	3	2.85	15°	6	27.1	45	12.64	13.03	13.44	13.89	14.91	
08-00537-01504		14	2.5	3	2.85	15°	6	30.1	50	14.71	15.17	15.66	16.19	17.39	
08-00537-01505		16	2.5	3	2.85	15°	6	28.1	50	16.77	17.31	17.88	18.49	19.88	
08-00537-01506	R2	20	2.5	3	2.85	15°	6	29.1	55	20.91	21.58	22.31	23.09	24.85	
08-00537-02000		8	3	4	3.8	15°	6	32.8	45	8.58	8.81	9.06	9.33	9.93	
08-00537-02001		10	3	4	3.8	15°	6	30.8	45	10.65	10.95	11.28	11.63	12.42	
08-00537-02002		12	3	4	3.8	15°	6	28.8	45	12.72	13.09	13.49	13.93	14.90	
08-00537-02004		15	3	4	3.8	15°	6	30.8	50	15.82	16.30	16.82	17.38	18.63	
08-00537-02005		20	3	4	3.8	15°	6	30.8	55	20.99	21.65	22.36	23.13	Free	
08-00537-02006	R2.5	25	3	4	3.8	15°	6	30.8	60	26.16	27.00	27.90	28.88	Free	
08-00537-02502		10	3.5	5	4.8	15°	6	32.7	45	10.63	10.92	11.22	11.55	Free	
08-00537-02503		15	3.5	5	4.8	15°	6	27.7	45	15.8	16.27	16.77	Free	Free	
08-00537-02504		20	3.5	5	4.8	15°	6	27.7	50	20.97	21.62	Free	Free	Free	
08-00537-03000	R3	10	6	6	5.7	—	6	34.4	45	Free	Free	Free	Free	Free	
08-00537-03001		15	6	6	5.7	—	6	29.4	45	Free	Free	Free	Free	Free	
08-00537-03002		20	6	6	5.7	—	6	29.4	50	Free	Free	Free	Free	Free	
08-00537-03003		25	6	6	5.7	—	6	29.4	55	Free	Free	Free	Free	Free	
08-00537-03004		30	6	6	5.7	—	6	29.4	60	Free	Free	Free	Free	Free	

How to order When you order, indicate MRBSH230SF (R) × (ℓ1).

※(γ) is reference value.

● Neck taper angle (γ) of MRBSH230SF is 15°. Our other products have a neck taper angle (γ) of 12°.

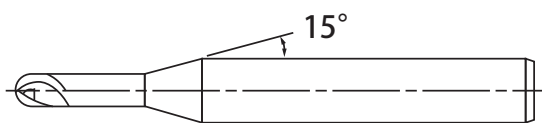

MRBSH230SF

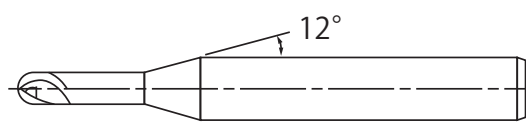

Our other products have a neck taper angle (γ) of 12°

MRBSH230SF

Recommended Milling Conditions

Work Material			High Speed Steels / Hardened Steels SKH51・SKD11 (~62HRC)				High Speed Steels SKH55・HAP40 (~66HRC)				High Speed Steels SKH57・HAP72 (~70HRC)			
Radius	Under Neck Length	L/D	Depth of Cut		Feed	Spindle Speed	Depth of Cut		Feed	Spindle Speed	Depth of Cut		Feed	Spindle Speed
			ap mm	ae mm	mm/min	min ⁻¹	ap mm	ae mm	mm/min	min ⁻¹	ap mm	ae mm	mm/min	min ⁻¹
R0.05	0.2	2	0.002	0.005	100	40,000	0.002	0.003	70	40,000	0.002	0.003	50	40,000
	0.3	3	0.002	0.005	70	40,000	0.002	0.003	50	40,000	0.002	0.003	40	40,000
	0.5	5	0.001	0.003	50	40,000	0.001	0.002	30	40,000	0.001	0.002	20	40,000
R0.075	0.3	2	0.002	0.005	150	40,000	0.002	0.003	100	40,000	0.002	0.003	80	40,000
	0.5	3.3	0.002	0.005	120	40,000	0.002	0.003	70	40,000	0.002	0.003	50	40,000
R0.1	0.3	1.5	0.005	0.005	300	40,000	0.003	0.003	200	40,000	0.003	0.003	150	40,000
	0.5	2.5	0.005	0.005	280	40,000	0.003	0.003	180	40,000	0.003	0.003	130	40,000
	0.75	3.75	0.003	0.005	200	40,000	0.002	0.003	150	40,000	0.002	0.003	110	40,000
	1	5	0.002	0.003	160	40,000	0.001	0.002	120	40,000	0.001	0.002	90	40,000
R0.15	0.5	1.7	0.007	0.01	300	40,000	0.003	0.005	280	40,000	0.003	0.005	210	40,000
	0.6	2	0.005	0.007	300	40,000	0.003	0.005	250	40,000	0.003	0.005	180	40,000
	0.75	2.5	0.005	0.007	280	40,000	0.003	0.005	230	40,000	0.003	0.005	170	40,000
	1	3.3	0.005	0.007	250	40,000	0.003	0.005	200	40,000	0.003	0.005	150	40,000
R0.2	1.5	5	0.003	0.005	180	40,000	0.002	0.003	120	40,000	0.002	0.003	90	40,000
	0.5	1.25	0.03	0.03	720	40,000	0.009	0.02	580	40,000	0.009	0.02	420	35,000
	0.8	2	0.02	0.03	720	40,000	0.008	0.02	580	40,000	0.008	0.02	420	35,000
	1	2.5	0.02	0.03	720	40,000	0.008	0.02	580	40,000	0.008	0.02	400	35,000
	1.5	3.75	0.01	0.02	500	40,000	0.005	0.01	400	40,000	0.005	0.01	280	35,000
R0.25	2	5	0.007	0.01	380	40,000	0.005	0.007	300	40,000	0.005	0.007	220	35,000
	2.5	6.25	0.005	0.007	300	40,000	0.003	0.005	260	40,000	0.003	0.005	190	35,000
	1	2	0.02	0.03	860	40,000	0.01	0.02	650	35,000	0.01	0.02	450	30,000
	1.5	3	0.01	0.03	720	40,000	0.007	0.02	520	35,000	0.007	0.02	350	30,000
	2	4	0.01	0.02	650	40,000	0.007	0.01	400	35,000	0.007	0.01	270	30,000
R0.3	2.5	5	0.007	0.01	530	40,000	0.005	0.007	360	35,000	0.005	0.007	240	30,000
	3	6	0.007	0.01	420	35,000	0.005	0.007	320	35,000	0.005	0.007	220	30,000
	1	1.7	0.03	0.06	1,000	40,000	0.02	0.05	720	30,000	0.02	0.05	540	25,000
	1.5	2.5	0.03	0.06	1,000	40,000	0.02	0.05	720	30,000	0.02	0.05	540	25,000
	2	3.3	0.03	0.06	1,000	40,000	0.02	0.05	720	30,000	0.02	0.05	540	25,000
	2.5	4.1	0.02	0.04	840	40,000	0.02	0.03	640	30,000	0.02	0.03	480	25,000
R0.4	3	5	0.02	0.04	840	40,000	0.02	0.03	600	30,000	0.02	0.03	450	25,000
	3.5	5.9	0.01	0.03	600	30,000	0.01	0.02	420	30,000	0.01	0.02	310	25,000
	4	6.7	0.01	0.03	600	30,000	0.01	0.02	420	30,000	0.01	0.02	310	25,000
	2	2.5	0.07	0.1	1,600	35,000	0.05	0.1	1,200	30,000	0.03	0.1	900	25,000
R0.5	3	3.75	0.05	0.1	1,600	35,000	0.05	0.05	1,200	30,000	0.03	0.05	900	25,000
	4	5	0.04	0.06	1,200	30,000	0.03	0.05	860	25,000	0.02	0.05	640	20,000
	5	6.25	0.03	0.05	1,000	25,000	0.02	0.03	620	25,000	0.015	0.03	460	20,000
	2	2	0.1	0.2	2,000	30,000	0.08	0.1	1,400	25,000	0.05	0.1	1,000	20,000
	2.5	2.5	0.1	0.2	2,000	30,000	0.08	0.1	1,400	25,000	0.05	0.1	1,000	20,000
R0.5	3	3	0.1	0.2	2,000	30,000	0.08	0.1	1,400	25,000	0.05	0.1	1,000	20,000
	4	4	0.05	0.15	1,600	28,000	0.05	0.1	1,200	25,000	0.03	0.1	900	20,000
	5	5	0.04	0.1	1,400	25,000	0.03	0.05	920	20,000	0.02	0.05	700	16,000
	6	6	0.04	0.05	1,200	22,000	0.02	0.05	740	20,000	0.015	0.05	550	16,000

Work Material			High Speed Steels / Hardened Steels SKH51・SKD11 (~62HRC)				High Speed Steels SKH55・HAP40 (~66HRC)				High Speed Steels SKH57・HAP72 (~70HRC)			
Radius	Under Neck Length	L/D	Depth of Cut		Feed	Spindle Speed	Depth of Cut		Feed	Spindle Speed	Depth of Cut		Feed	Spindle Speed
			ap mm	ae mm	mm/min	min ⁻¹	ap mm	ae mm	mm/min	min ⁻¹	ap mm	ae mm	mm/min	min ⁻¹
R0.6	2.4	2	0.1	0.2	2,000	30,000	0.08	0.1	1,600	25,000	0.05	0.1	1,200	20,000
	4	3.3	0.1	0.2	2,000	30,000	0.06	0.1	1,600	25,000	0.05	0.1	1,200	20,000
	6	5	0.05	0.1	1,400	25,000	0.03	0.07	1,000	20,000	0.02	0.07	750	16,000
	8	6.7	0.03	0.07	1,200	22,000	0.02	0.05	850	20,000	0.015	0.05	650	16,000
R0.75	3	2	0.1	0.3	2,500	30,000	0.1	0.2	2,000	25,000	0.06	0.2	1,500	20,000
	4	2.7	0.1	0.3	2,000	25,000	0.1	0.2	1,600	22,000	0.06	0.2	1,200	18,000
	6	4	0.1	0.2	1,600	22,000	0.1	0.1	1,200	20,000	0.06	0.1	950	16,000
	8	5.3	0.05	0.2	1,400	20,000	0.05	0.1	1,000	18,000	0.03	0.1	700	13,000
	10	6.7	0.05	0.1	1,200	18,000	0.05	0.05	850	16,000	0.03	0.05	650	13,000
R0.8	8	5	0.07	0.2	1,400	20,000	0.05	0.1	1,000	16,000	0.03	0.1	750	13,000
R1	3	1.5	0.2	0.5	2,500	25,000	0.15	0.3	2,000	20,000	0.1	0.3	1,500	16,000
	4	2	0.2	0.5	2,500	25,000	0.15	0.3	2,000	20,000	0.1	0.3	1,500	16,000
	6	3	0.2	0.3	2,000	22,000	0.15	0.3	1,600	20,000	0.1	0.3	1,200	16,000
	8	4	0.1	0.2	1,600	18,000	0.1	0.15	1,200	16,000	0.06	0.15	950	13,000
	10	5	0.1	0.2	1,400	16,000	0.1	0.1	1,000	14,000	0.06	0.1	750	11,000
	12	6	0.07	0.1	1,200	14,000	0.05	0.1	850	12,000	0.03	0.1	650	9,500
R1.25	6	2.4	0.2	0.5	2,500	20,000	0.15	0.4	2,000	18,000	0.1	0.4	1,500	14,000
	8	3.2	0.2	0.3	2,100	20,000	0.15	0.3	1,800	18,000	0.1	0.3	1,300	14,000
	10	4	0.15	0.2	1,800	18,000	0.1	0.15	1,500	16,000	0.06	0.15	1,100	13,000
	15	6	0.07	0.15	1,200	14,000	0.05	0.1	900	12,000	0.03	0.1	700	9,500
R1.5	6	2	0.2	0.6	2,500	18,000	0.2	0.5	2,000	15,000	0.12	0.5	1,500	12,000
	8	2.7	0.2	0.6	2,500	18,000	0.2	0.5	2,000	15,000	0.12	0.5	1,500	12,000
	10	3.3	0.2	0.4	2,100	18,000	0.15	0.3	1,800	15,000	0.1	0.3	1,300	12,000
	12	4	0.2	0.4	2,000	18,000	0.1	0.3	1,500	15,000	0.06	0.3	1,100	12,000
	14	4.7	0.1	0.3	1,600	16,000	0.1	0.2	1,200	12,000	0.06	0.2	900	10,000
	16	5.3	0.1	0.3	1,600	16,000	0.1	0.2	1,200	12,000	0.06	0.2	900	10,000
	20	6.7	0.08	0.2	1,200	14,000	0.08	0.1	850	12,000	0.06	0.1	650	9,500
R2	8	2	0.2	0.8	2,500	15,000	0.2	0.6	2,000	12,000	0.15	0.6	1,500	9,500
	10	2.5	0.2	0.8	2,500	15,000	0.2	0.6	2,000	12,000	0.15	0.6	1,500	9,500
	12	3	0.2	0.8	2,500	15,000	0.2	0.6	2,000	12,000	0.15	0.6	1,500	9,500
	15	3.75	0.2	0.8	2,000	15,000	0.15	0.6	1,600	12,000	0.12	0.6	1,200	9,500
	20	5	0.1	0.6	1,700	14,000	0.1	0.4	1,200	10,000	0.08	0.4	900	8,000
	25	6.25	0.1	0.4	1,200	14,000	0.1	0.2	850	10,000	0.08	0.2	650	8,000
R2.5	10	2	0.2	1.2	2,500	12,000	0.2	0.7	2,000	10,000	0.15	0.7	1,500	8,000
	15	3	0.2	1.2	2,500	12,000	0.2	0.7	2,000	10,000	0.15	0.7	1,500	8,000
	20	4	0.2	1	2,000	10,000	0.15	0.6	1,600	8,500	0.12	0.6	1,200	6,500
R3	10	1.7	0.3	1.2	2,500	8,000	0.2	1	2,000	7,000	0.15	1	1,500	5,500
	15	2.5	0.3	1.2	2,500	8,000	0.2	1	2,000	7,000	0.15	1	1,500	5,500
	20	3.3	0.3	1.2	2,500	8,000	0.2	1	2,000	7,000	0.15	1	1,500	5,500
	25	4.1	0.2	1	2,200	8,000	0.15	0.7	1,600	7,000	0.12	0.7	1,200	5,500
	30	5	0.2	1	1,800	7,000	0.15	0.7	1,300	6,500	0.12	0.7	950	5,000
Notes			<p>※1 Depth of cut ap indicates Axial Depth of Cut, ae indicates Radial Depth of Cut.</p> <p>※2 In case of chattering etc., please adjust cutting conditions if necessary.</p> <p>※3 At point where cutting load is high such as at corners, pay attention to setting cutting conditions and tool paths particularly.</p> <p>※4 Adjust both spindle speed and feed at the same rate.</p> <p>※5 A shrink fit type is recommended for holding tool. When using collet type or others, strictly adhere to minimum gripping length.</p> <p>※6 We recommend using oil mist coolant.</p>											

Machining case 1

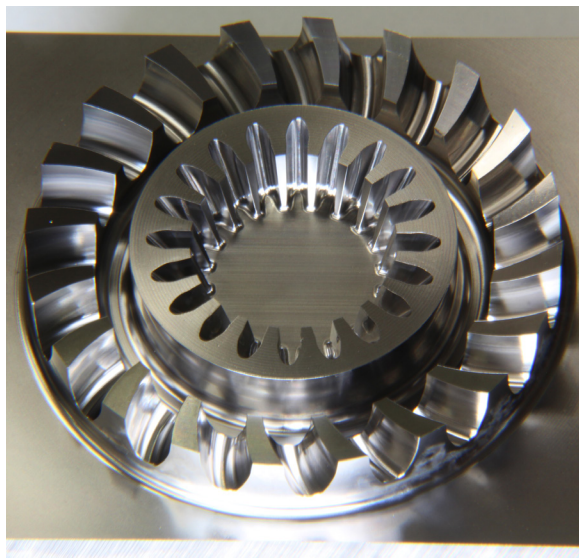

Material : **HAP72 (70HRC)**

Coolant : **Oil mist**

Total machining time : **11hr 33min**

Work size : Φ 40 (Base 50x45 mm)

Cutting depth : 6mm

Peripheral gear

Peripheral gear machining time : **6hr 57min**

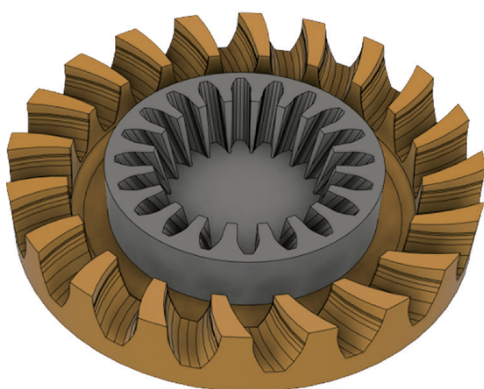

Milling part

Process	Roughing	Semi-finishing	Finishing
Tool	MRBSH230SF R1x6	MRBSH230SF R1x6	MRBSH230SF R1x6
Spindle speed [min ⁻¹]	12,000		
Feed [mm/min]	1,800		1,200
Depth of cut [mm]	ap 0.06 ae 0.3	Pick feed 0.1	Pick feed 0.03
Stock [mm]	0.03	0.01	—
Machining time	2hr 36min	51 min	3hr 30min

Inside gear

Inside gear machining time : **4hr 36min**

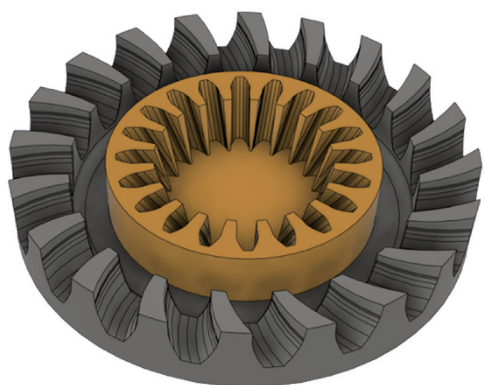

Milling part

Process	Roughing	Semi-finishing	Finishing
Tool	MRBSH230SF R0.5x6	MRBSH230SF R0.5x6	MRBSH230SF R0.5x6
Spindle speed [min ⁻¹]	14,000		
Feed [mm/min]	1,000		700
Depth of cut [mm]	ap 0.03 ae 0.15	Pick feed 0.05	Pick feed 0.02
Stock [mm]	0.03	0.01	—
Machining time	3hr 6min	22 min	1hr 8min

Tool wear

Cutting condition

n= 12,000 min⁻¹, Roughing / Semi-finishing Vf= 1,800 mm/min, Finishing Vf= 1,200 mm/min

Tool wear after cutting on HAP72 (70HRC)	MRBSH230SF R1 × 6		
	Roughing 2hr 36min	Semi-finishing 51 min	Finishing 3hr 30min
Rake face			
Peripheral cutting edge			
R end cutting edge			

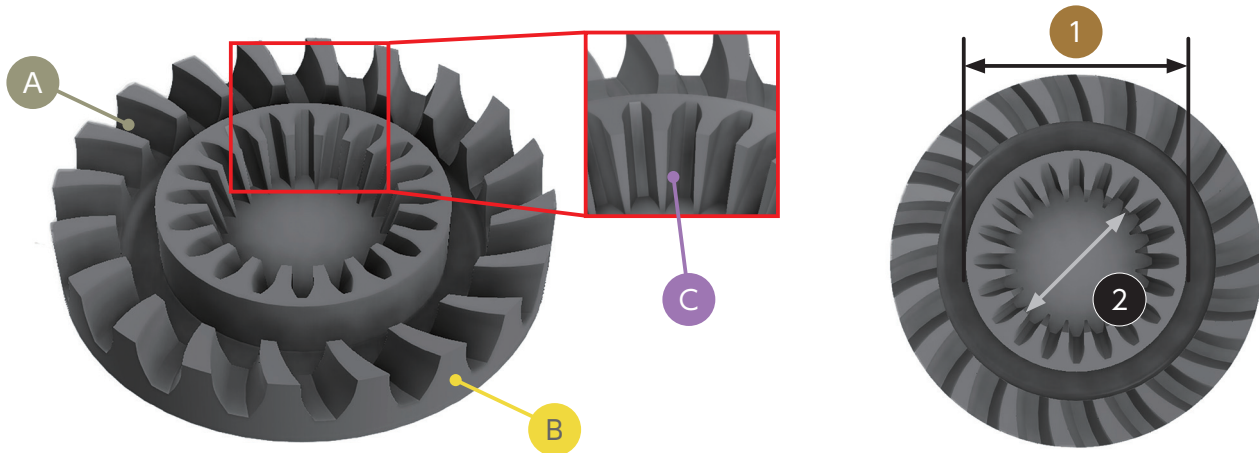

Roughness

Unit [μm]

	A	B	C
Tool	MRBSH230SF R1×6		MRBSH230SF R0.5×6
Ra	0.133	0.137	0.282
Rz	0.815	1.336	1.676

Measuring instrument: Keyence VK-X250

Accuracy

Unit [mm]

	1	2
Tool	MRBSH230SF R1×6	MRBSH230SF R0.5×6
Target	24.500	15.480
Actual	24.505	15.472
Error	0.005	0.008

Measuring instrument: Nikon microscope MM-60

Machining Case 2

Fine blanking machining sample

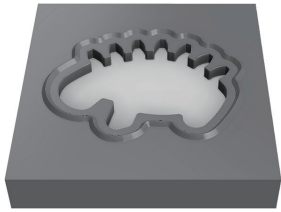

Material : **YXR3 (61HRC)**

Coolant : **Oil mist**

Total machining time : **7hr 27min**

Work size : 60×60mm

Cutting depth : 4mm

※ Total machining time includes WEDM process (white part) both blank holder part and die part

Milling part

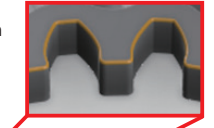

Blank holder

Machining time :
5hr 41min

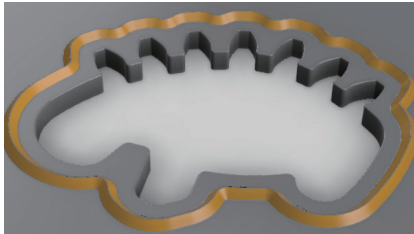

Die

Machining time :
1hr 46min



Milling part

Process	Blank holder				Die		Die		
	Roughing	Semi-Finishing	Stock removal	Finishing	Stock removal	Stock removal	Roughing	Finishing	
Tool	MRBSH230SF R1×4		MRBSH230SF R0.5×2	MRBSH230SF R0.25×1.5	MRBSH230SF R0.2×1	MRBSH230SF R0.25×1.5	MRBSH230SF R0.2×1	MRBSH230SF R0.2×1	
Spindle speed [min ⁻¹]	25,000		30,000				30,000		
Feed [mm/min]	2,500		1,000	540	540	540			
Depth of cut [mm]	ap 0.2 ae 0.5	Pick feed 0.05		pf:0.03		pf:0.02		ap 0.01 ae 0.03	pf:0.01
Stock [mm]	0.03	0.01		- (Only corner part 0.005)		-		0.003	-
Machining time	39 min	40 min	1hr 3min		47 min	1hr 26min		1hr 11min	35 min

※ pf : pick feed

※ pf : pick feed

Roughness

Unit [μm]

	1	2
Tool	MRBSH230SF R0.5×2	MRBSH230SF R0.2×1
Ra	0.145	0.080
Rz	1.192	0.521

Measuring instrument : Keyence VK-X250

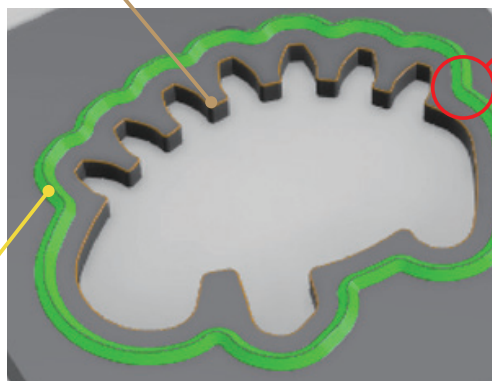
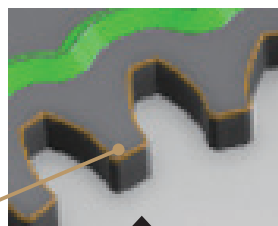

Accuracy

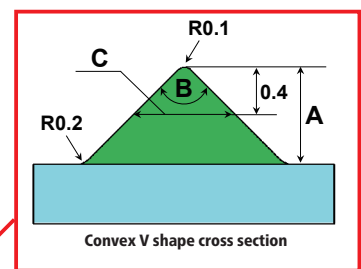

	A	B	C
Target	0.958mm	90°0'00"	0.883mm
Actual	0.958mm	90°15'10"	0.888mm
Error	0.000mm	0°15'10"	0.005mm

Measuring instrument : Keyence VK-X250

Machining Case 3



Material : **HAP40 (65HRC)**

Coolant : **Oil mist**

Total machining time : **8hr 46min**

Work size : Φ 25x50mm

Cutting depth : 6mm

Process	Roughing	Stock removal	Semi-finishing	Finishing
Tool	MRBSH230SF R1x6	MRBSH230SF R0.5x5	MRBSH230SF R0.5x5	MRBSH230SF R0.5x5
Spindle speed [min ⁻¹]	20,000			12,000
Feed [mm/min]	1,600	920	920	460
Depth of cut [mm] ap x ae	0.15x0.3	0.03x0.1	Side face: 0.03x0.02 Surface: 0.02x0.05	Pick feed 0.015
Stock [mm]	0.03		0.01	—
Machining time	24 min	3hr 8min	1hr 8min	4hr 6min

Roughness

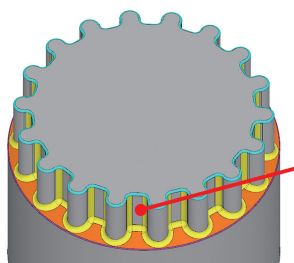

Unit [μ m]	
	Side face
Ra	0.031
Rz	0.225

Measuring Instrument : Keyence VK-X250

R edge retreat amount
0.003mm after side
finishing for 2 hours

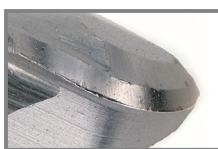

0.003mm

Accuracy

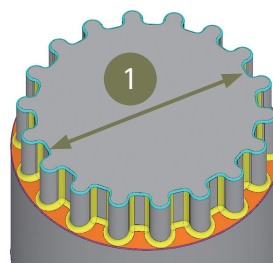

Unit [mm]	
	1
Target	20.644
Actual	20.647
Error	0.003

Measuring instrument : Nikon microscope MM-60

Tool wear

Process	Roughing	Stock removal	Semi-finishing	Finishing
Tool	MRBSH230SF R1x6	MRBSH230SF R0.5x5	MRBSH230SF R0.5x5	MRBSH230SF R0.5x5
Rake side				
Peripheral cutting edge				
R end cutting edge				

NS TOOL CO.,LTD.

www.ns-tool.com
6F., Sumitomo Fudosan Oimachi Ekimae Bldg.,
1-28-1 Oi, Shinagawa-ku, Tokyo 140-0014, Japan
TEL. +81-3-3774-2459 FAX. +81-3-3774-2460

NS TOOL USA, INC.

us.ns-tool.com
2265 Building #3, Star CT.,
Rochester Hills, MI 48309, USA
TEL. +1-248-829-1960



CAUTION

Attention on Safety

- 1) When removing tools from cases, be careful of getting-out of tools and don't touch directly the cutting edges.
- 2) Never touch the cutting edges directly with bare hand.
- 3) Use safety covers and eye protection, as tools may be broken.
- 4) Use holders, etc. that match the tools and nature of the processing operations. The tool should be firmly attached to the holder to prevent shaking.
- 5) The work materials clamp firmly.
- 6) Make sure of dimensions of tools and work pieces before starting operation.
- 7) It is necessary to adjust conditions according to the dimensions of work materials and the machine.
- 8) Select a cutting fluid appropriate to the particular usage. Using a non-water cutting fluid could lead to fires due to sparks generated during processing or heat caused by breakage. Ensure that you take proper fire-prevention measures.
- 9) If abnormal sound, etc. occurs during processing, stop the machine immediately.
- 10) Don't modify tools.

69.5
22'07



■ Specifications may change without notice for improvement.